

# Instruction manual

## HEPA filter

### Series HF2

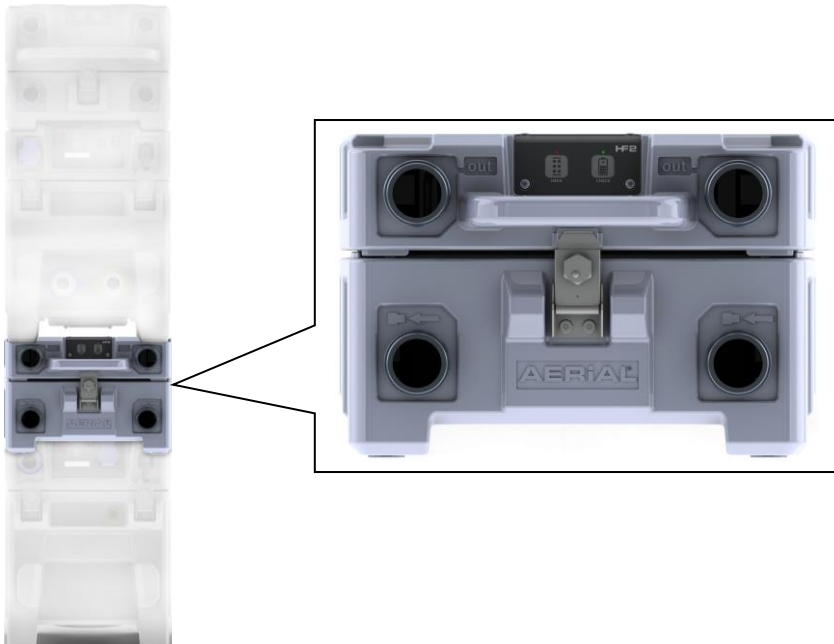



This instruction manual shall not be reproduced, copied and distributed, neither in parts nor completely, without the manufacturer's written permit.

All rights reserved.

The instruction manual is based on the technical and product-specific parameters. The manufacturer reserves the right to add supplementary information to the instruction manual.

Using a device outside the specified conditions and contrary to its designated use will lead to the forfeiture of all warranty claims.

As of: 05\_2016

<b>1</b>	<b>Notes on this instruction manual</b>	<b>2</b>
	Target groups	2
	Conventions	2
	Designated use	3
<b>2</b>	<b>Safety</b>	<b>3</b>
	Safety devices	3
	Hazards from accessories	3
	Authorised operator	4
	User	4
	Safety instructions	4
<b>3</b>	<b>Construction</b>	<b>5</b>
<b>4</b>	<b>Transport and installation</b>	<b>6</b>
	Transport	6
	Scope of delivery	6
	Operating conditions	6
	Installation	6
<b>5</b>	<b>Operation and operator control</b>	<b>7</b>
<b>6</b>	<b>Maintenance and service</b>	<b>8</b>
	Filter change	8
	Filter installation	9
	Operation of display	9
<b>7</b>	<b>Troubleshooting</b>	<b>10</b>
	Storage	10
	Disposal	10
<b>8</b>	<b>Specifications</b>	<b>11</b>

### 1 Notes on this instruction manual

This instruction manual is part of the product. It contains all important information on how to transport, install, operate, store and dispose of the device from **AERIAL** properly and safely. Therefore keep this instruction manual in a safe place.

#### Target groups

This instruction manual addresses the users and operators of the devices manufactured by **AERIAL**. They must have read and understood the instruction manual. The physical and psychological preconditions for proper and safety-conscious handling of the devices must always be guaranteed.

#### Conventions

##### Warnings

In this instruction manual you will find information intended to warn you of possible hazards at the beginning of a specific action.



**DANGER**

#### Type and source of hazard

This symbol in connection with the signal word "DANGER" refers to a life-threatening situation. Failure to observe this warning will result in serious, fatal injury.

- ➔ This arrow marks precise steps to avert danger which must always be performed.



**WARNING**

#### Type and source of hazard

This symbol in connection with the signal word "WARNING" refers to a dangerous situation. Failure to observe this warning can result in life-threatening injury and death.

- ➔ This arrow marks precise steps to avert danger which must be performed.



**CAUTION**

#### Type and source of hazard

This symbol in connection with the word "CAUTION" warns of minor or moderate injury and potential material damage.

- ➔ Measures to prevent personal injury or material damage are described here.



In this box you find tips and information concerning the use of the device.

### Designated use

The HEPA filter HF2 is designed for use with a side channel compressor or the noise box VP2/VP3 as additional equipment for filtering mould spores and other suspended solids in drying of the screed insulation layer using a vacuum technique.

The HEPA filter HF2 is designed exclusively for use at atmospheric pressure. Designated use also involves observing the specified operating conditions (refer to page 6) and safety instructions (refer to page 4). Any use of the device going beyond the designated use specified above is considered contrary to its designated use.

Misuse is concerned if the HEPA filter HF2 is used for purposes not included in designated use. In these cases the manufacturer does not assume any liability for personal and material damage.

## 2 Safety

### Safety devices

The HEPA filter HF2 was subjected to thorough safety testing. Improper operation or misuse will cause danger to

- the operator,
- the device and other material property of the user,
- efficient operation of the device.

All persons involved in the installation, commissioning, operation, maintenance and servicing of the devices must

- be properly qualified,
- closely observe the instructions set out in this manual.

### Hazards from accessories

Air hoses and air filters must be properly installed. The operating elements must always be accessible.

### Authorised operator

The HEPA air filter HF2 may only be operated by persons commissioned and instructed by the user. In the working area the operator is responsible to third parties. For all activities on the device the responsibilities must be clearly defined and observed. Unclear competences are a safety risk.

### User

The user must

- make the instruction manual accessible to the operator,
- make sure that the operator has read and understood the instruction manual.

### Safety instructions

The devices must **not** be used under the following conditions:

- in rooms with potentially explosive atmospheres.
- in rooms with aggressive atmospheres, e.g. ammonia, wood acids.
- in rooms with water with a pH value outside the range from 4 to 9.
- In rooms with salt or liquids with a salt content > 1%.
- in rooms with high solvent concentration.
- in rooms with extreme dust load.

In addition the following must be observed when using the HEPA filter HF2:

- Original spare parts or spare parts approved by the manufacturer shall exclusively be used.

### 3 Construction

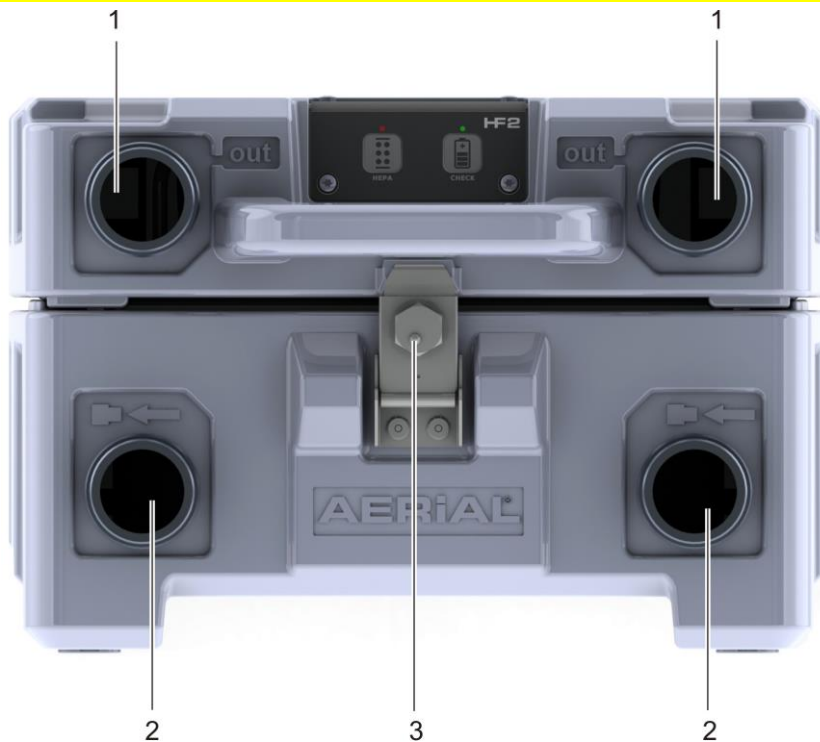

Fig. 1: HEPA Filter series HF2 - overview

1	Outlet side connection pipe Ø38 mm/Ø50 mm or Ø50 pipe	3	Tension lock
2	Intake side connection pipe Ø38 mm/Ø50 mm or Ø50 pipe		not shown: screw cap

The housing with the prefilter and the HEPA filter installed is ready for connection. The HEPA filter HF2 has no separate fan, and is used exclusively in connection with a side channel compressor or the noise box VP2/VP3 or a similar device, and a water separator VT2 or a similar device. On the intake



side the HEPA filter HF2 is installed between side channel compressor (noise box) and water separator.

### 4 Transport and installation

#### Transport

1. Remove the packaging material completely and dispose of according to the local regulations.
2. Check the delivery for completeness.
3. Use the front handle or the two handle recesses in the bottom to transport the HEPA filter HF2 to the place of installation.

#### Scope of delivery

- HEPA filter HF2 (4x tube connector, 2x screw cap, 6x gasket)
- One instruction manual

#### Operating conditions

The HEPA filter HF2 is designed for use with a side channel compressor or the noise box VP2/VP3 as additional equipment for filtering mould spores and other suspended solids in drying of the screed insulation layer using a vacuum technique. It works without problems in the temperature range from -10 °C to +40 °C.



Fig. 2: Fixing points for belt system

#### Installation

The devices can be stacked, and are provided with fixing points for a belt system on the right and left.

## 5 Operation and operator control



### **Danger of injury and damage to appliance**

Inadmissible ambient conditions and improper operation of the device may constitute a risk.

- ➡ Read the instruction manual before commissioning the HEPA filter HF2.

In the vacuum mode: Connect the suction connection of the side channel compressor or of a noise box (VP2/VP3) via a hose with the connections on the outlet side (see fig. 1.1) of the HEPA filter HF2. Connect the water separator via a hose with the connections on the intake side (see fig. 1.2) of the HEPA filter HF2.

In the pressure mode: Connect the suction connection of the side channel compressor or of a noise box (VP2/VP3) via a hose with the connections on the outlet side (see fig. 1.1) of the HEPA filter HF2.

### 6 Maintenance and service

#### Filter change



#### Damage to the device

Cleaning agents can cause damage to surfaces.

➡ Use only mild detergents.

The cleaning intervals depend largely on the operating conditions. Therefore check your HEPA filter HF2 after each drying operation.

In order to guarantee trouble-free functioning of the device it must be regularly cleaned, and in particular the prefilter and the HEPA filter must be checked at regular intervals. To change the filter proceed as follows:

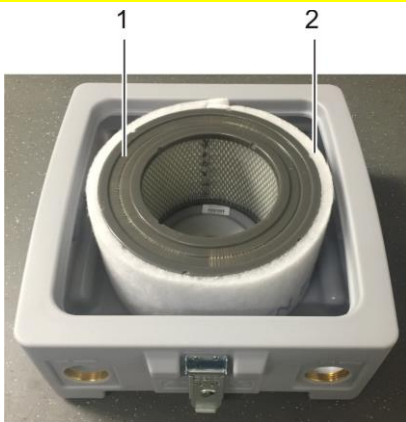

1	HEPA filter	2	Prefilter
---	-------------	---	-----------

Fig. 3: HEPA filter and prefilter

- Open the two tension locks on the front and rear sides. Remove the cover from the housing bottom part.
- Pull the HEPA filter out of the housing bottom part, and insert new HEPA filter or prefilter (see fig. 4 and 5 on the next page). Use only original filters to guarantee proper functioning of the HEPA filter HF2. The prefilter is fastened around the HEPA filter with Velcro (see fig. 3).
- Clean casing on the outside with a moist cloth.

Filter installation



Fig. 4: Changing the prefilter

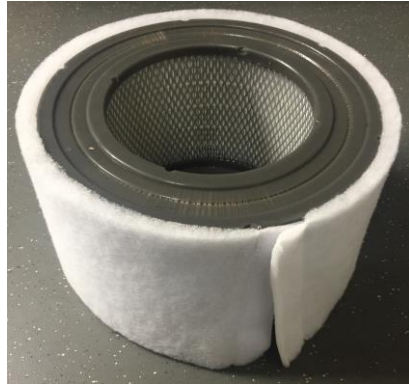

Fig. 5: Changing the HEPA filter

Operation of display

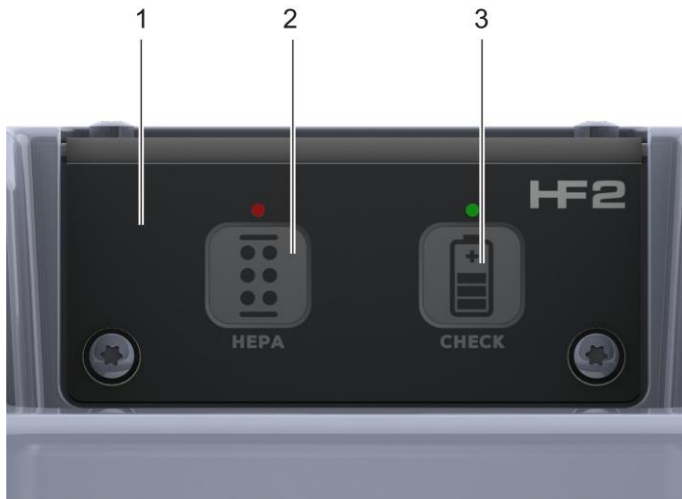

Fig. 6: Display

1	Display	3	Button for battery check
2	Clogging indicator		

Severe clogging of the filter is indicated by the clogging indicator flashing red. The indicator works only when the device is in operation.

By pressing the button for the battery check you can check the charging status of the battery for the clogging indicator. To change the battery loosen the four screws on the display and change the battery CR2032.

## 7 Troubleshooting

### Storage

Store the HEPA filter HF2 in conformity with the specified safety instructions (see page 4).

### Disposal

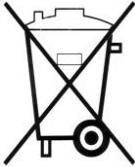

Please do not dispose of this device with the domestic waste. Dispose of the device in accordance with the legal regulations.

---

## 8 Specifications

General data		
Operating conditions	-10 °C to +40 °C	
Type	Unit	HF2
Prefilter		G4
HEPA filter		F13
Air circulation rate	cbm/h	up to 300
Dimensions H x W x D	mm	300/390/490
Weight	kg	6







Händlerstempel:

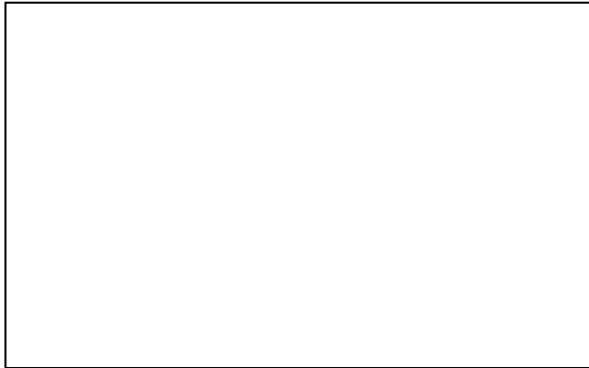

**AERIAL**<sup>®</sup>  
THE DRYING EXPERTS

Dantherm GmbH

Oststrasse 148 · D-22844 Norderstedt

Phone 0049 (0) 40 526 879 0 · Telefax 526 879 20

E-Mail: [info@dantherm.de](mailto:info@dantherm.de) · Internet: [www.aerial.de](http://www.aerial.de)